

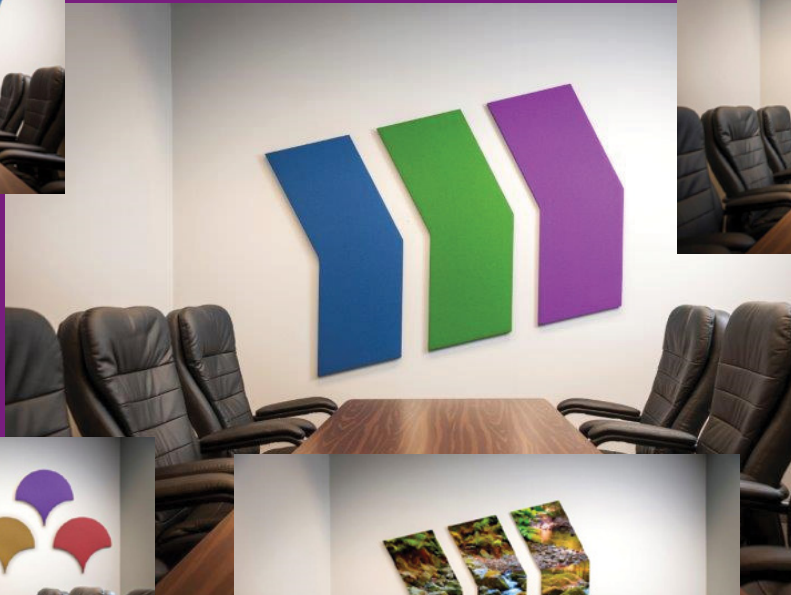

CUSTOM SHAPES



Help your walls come to life with our custom shaped panels! Using the latest in CNC machining, we offer endless possibilities with the ability to cut our panels into specialized shapes. Working Walls Solutions can cover your custom shaped panels with the same fabric, different fabrics or even digital images!

These are only some of the options we can offer:

- Chevrons
- Pointed Semicircles
- Ribbons
- Clouds

Use these ideas to put your own imagination to work. Have a shape in mind? Just ask!

Contact factory for pricing.

Chevron

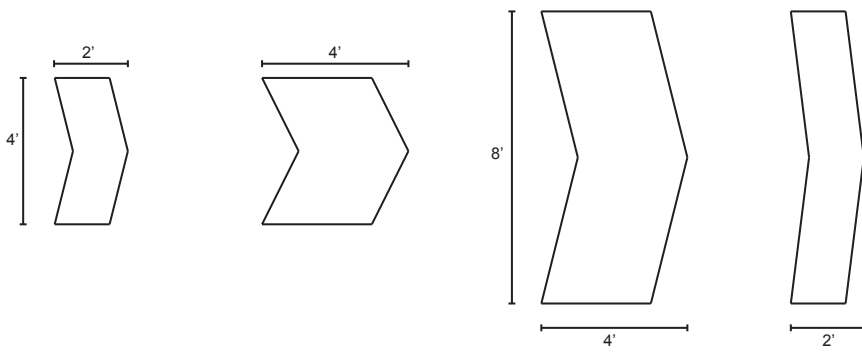

Pointed Half Circles

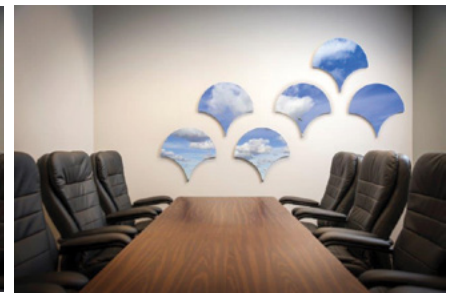
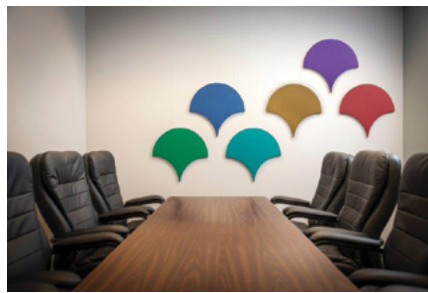
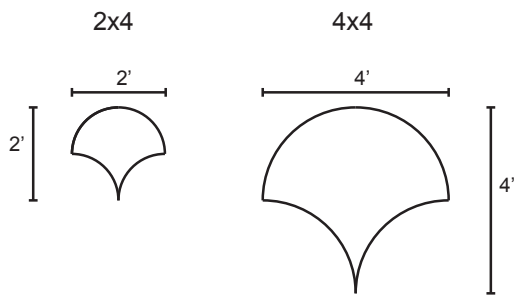

Ribbon

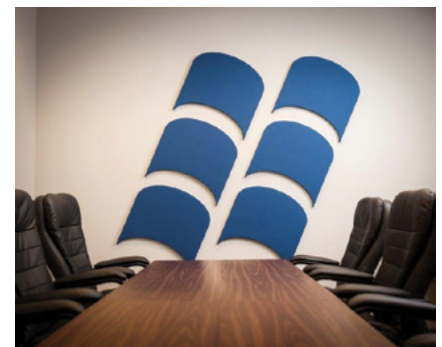
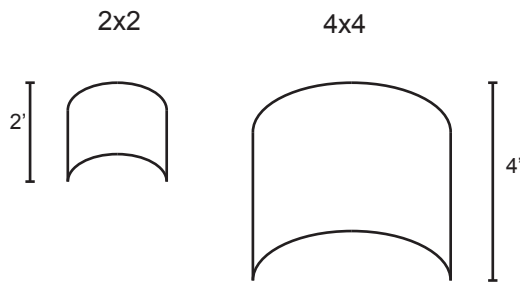

Cloud

